

VICINITY MAP
NTS

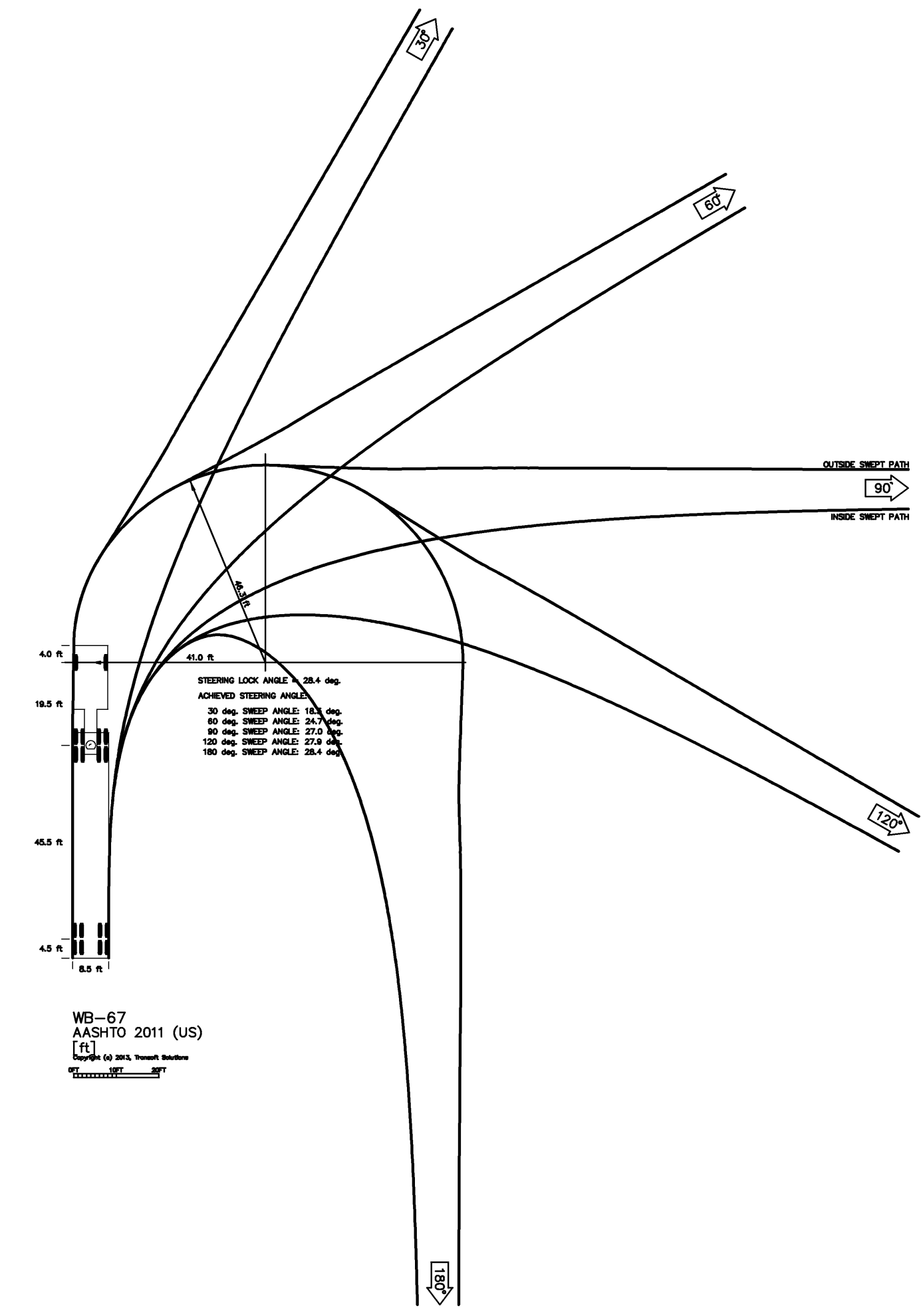

WB-67
AASHTO 2011 (US)
[E]
Copyright © 2011, Thomas Brothers
"Maximum" 90°

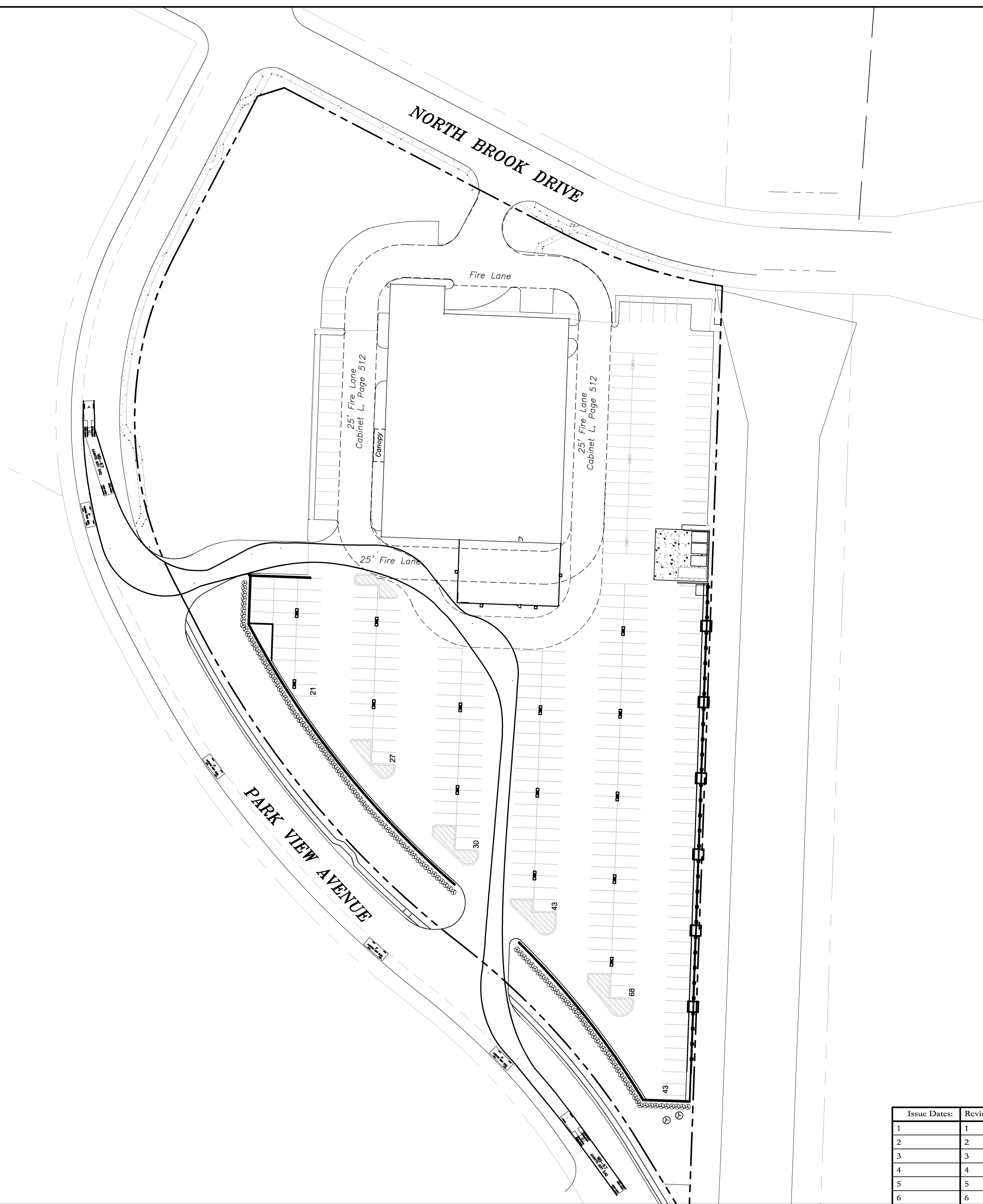
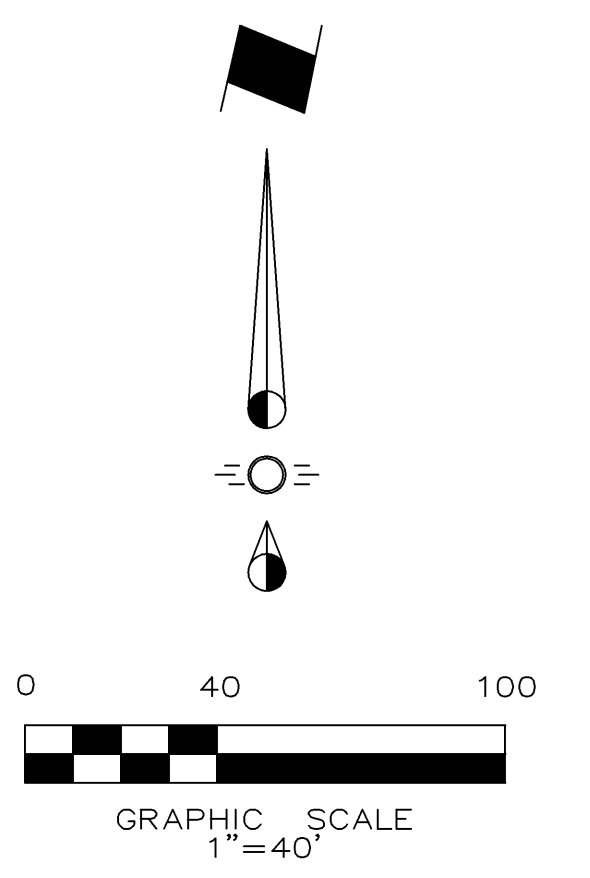
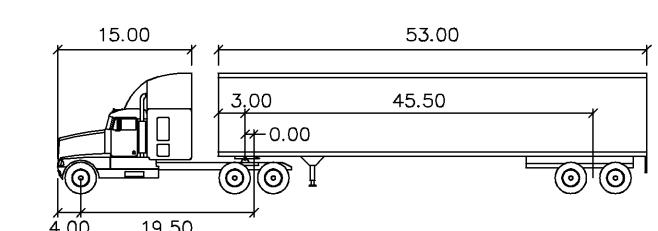

WB-67
Tractor Width : 15.00
Tractor Length : 8.50
Tractor Track : 8.00
Trailer Track : 8.50
Lock to Lock Time : 6.0
Steering Angle : 28.4
Articulating Angle : 75.0

Issue Dates:	Revisions:	Date:
1	1	
2	2	
3	3	
4	4	
5	5	
6	6	

CROSS ENGINEERING CONSULTANTS
131 S. Tennessee St. McKinney, Texas 75069
972.562.4409 Texas P.E. Firm No. F-5935

Drawn By:	Checked By:	Scale:
C.E.C.I.	C.E.C.I.	1"=40'

Autoturn Exhibit North-North
Variable Setback Layout
**BOB TOMES COLLISION CENTER
PARKING EXPANSION**
BLOCK Q, NORTH BROOK
MCKINNEY, TEXAS

Sheet No.
AE5
Project No.
13094

ENGINEER:
Cross Engineering Consultants, Inc.
131 S. Tennessee St.
McKinney, Texas 75069
Phone (972) 562-4409
Fax (972) 562-4471
Contact: Jon David Cross, P.E.

ARCHITECT:
IAM Construction
6900 North Dallas Parkway,
Suite 770
Plano, Texas 75024
Phone (972) 608-8988
Fax (972) 403-9292
Contact: Scott Bryant

SURVEYOR:
AJ Bedford Group, Inc.
301 N. Alamo Road
Rockwall, Texas 75087
Phone (972) 722-0225
Fax (972) 722-0361
Contact: Jay Bedford

Z:\PROJECTS\2013 Job Files\13094 Bob Tomes Collision\13094 AutoTurn-variable setback.dwg, 1/10/2014, 4:12:25 PM, RJP, 500-overwrite3, Chris Wilson

BOB TOMES COLLISION CENTER PARKING EXPANSION

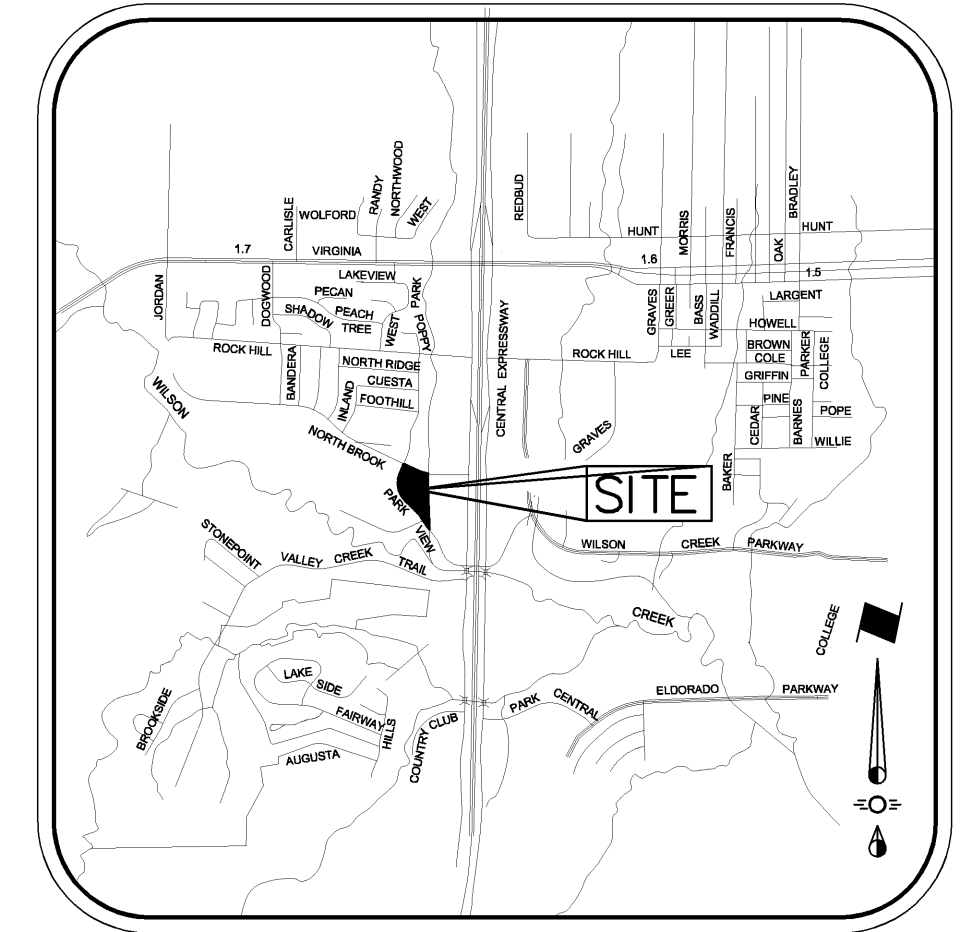

VICINITY MAP
NTS

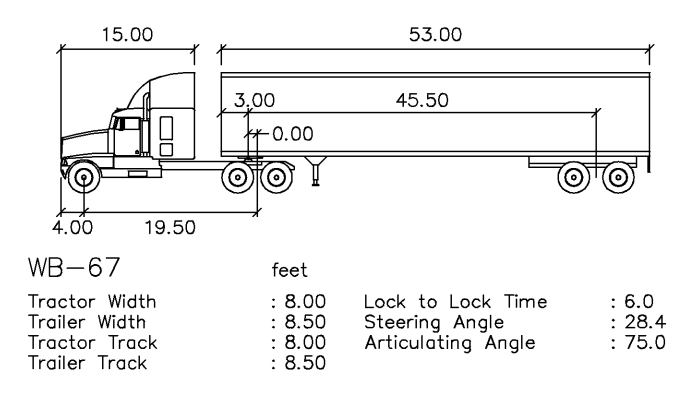
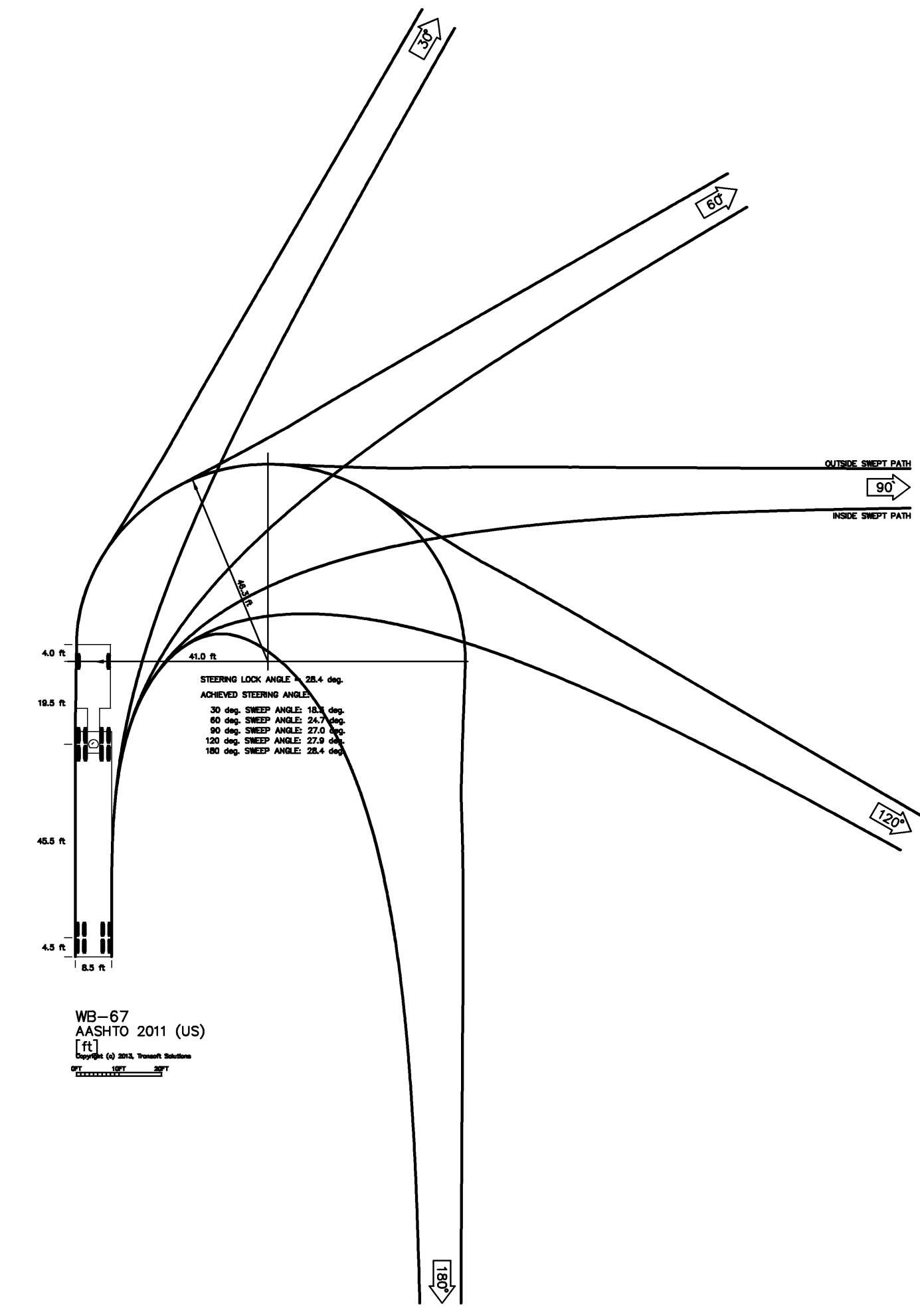
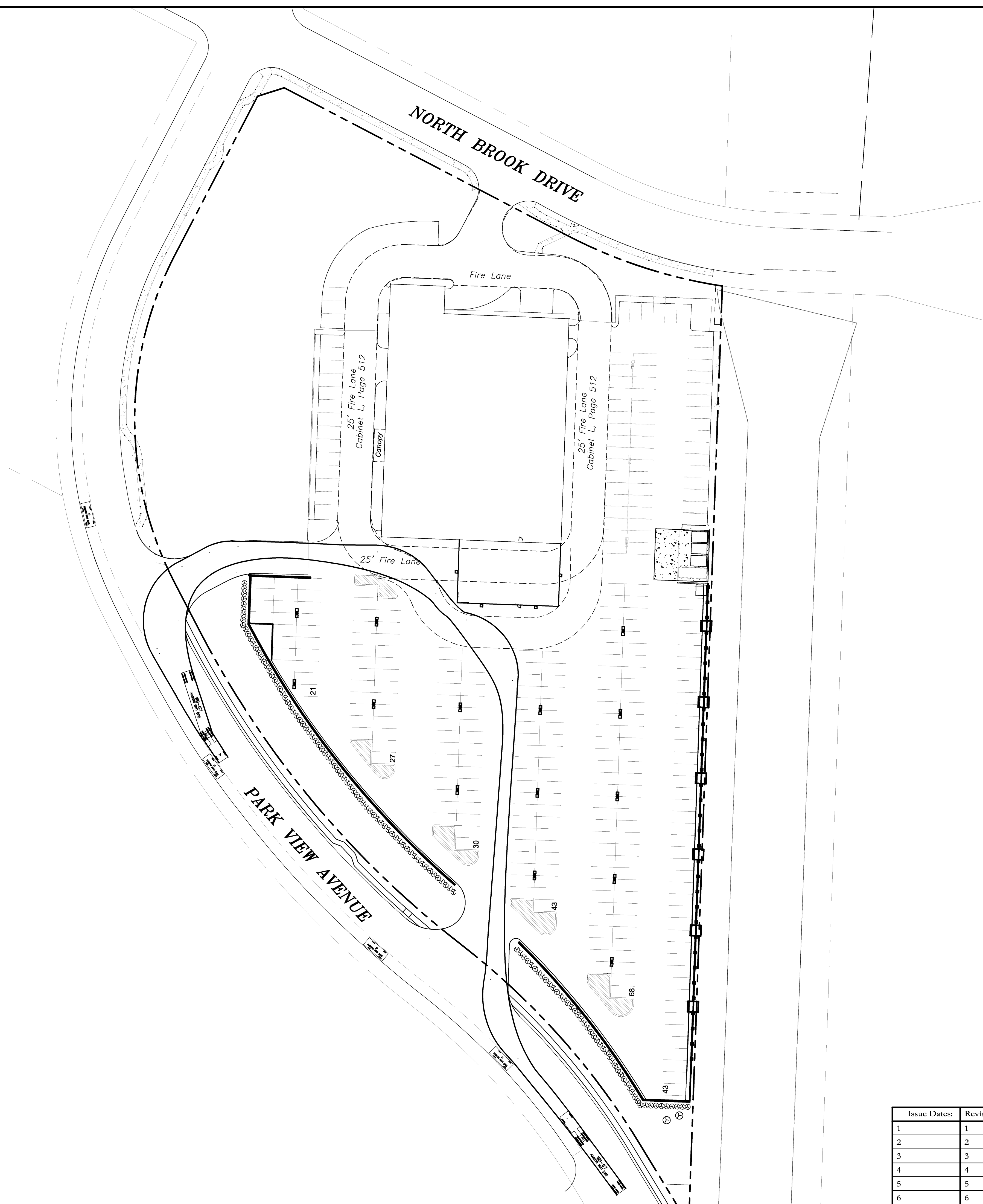
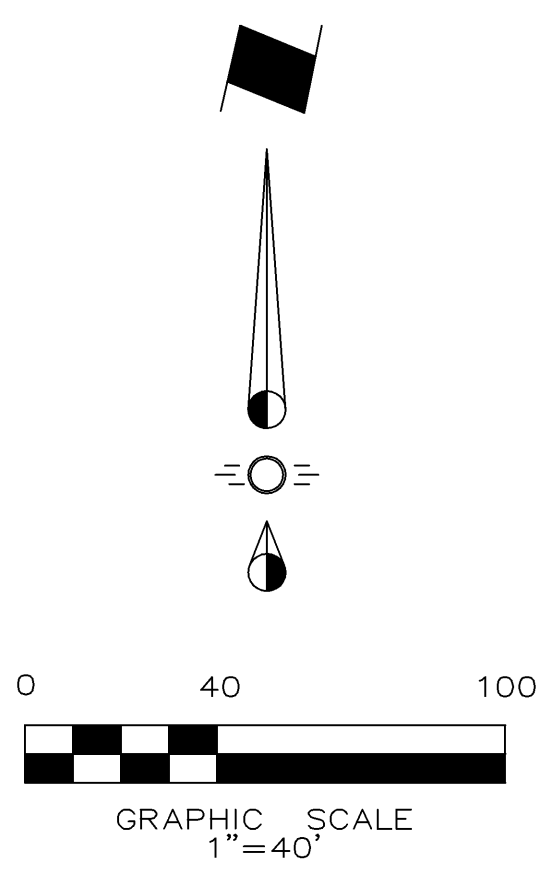

WB-67
feet
Tractor Width : 8.00
Trailer Width : 8.50
Tractor Track : 8.00
Trailer Track : 8.50
Lock to Lock Time : 6.0
Steering Angle : 28.4
Articulating Angle : 75.0

Issue Dates:	Revisions:	Date:
1	1	
2	2	
3	3	
4	4	
5	5	
6	6	

CROSS ENGINEERING CONSULTANTS
 131 S. Tennessee St. McKinney, Texas 75069
 972.562.4409 Texas P.E. Firm No. F-5935

Drawn By:	Checked By:	Scale:
C.E.C.I.	C.E.C.I.	1"=40'

Autoturn Exhibit North-South
 Variable Setback Layout
BOB TOMES COLLISION CENTER
PARKING EXPANSION
BLOCK Q, NORTH BROOK
McKINNEY, TEXAS

Sheet No.
AE6
Project No.
13094

Z:\PROJECTS\2013 Job Files\13094 Bob Tomes Collision\13094 AutoTurn-variable setback.dwg, 1/10/2014, 4:13:37 PM, RJP, 500-overwrite3, Chris Wilson

BOB TOMES COLLISION CENTER PARKING EXPANSION

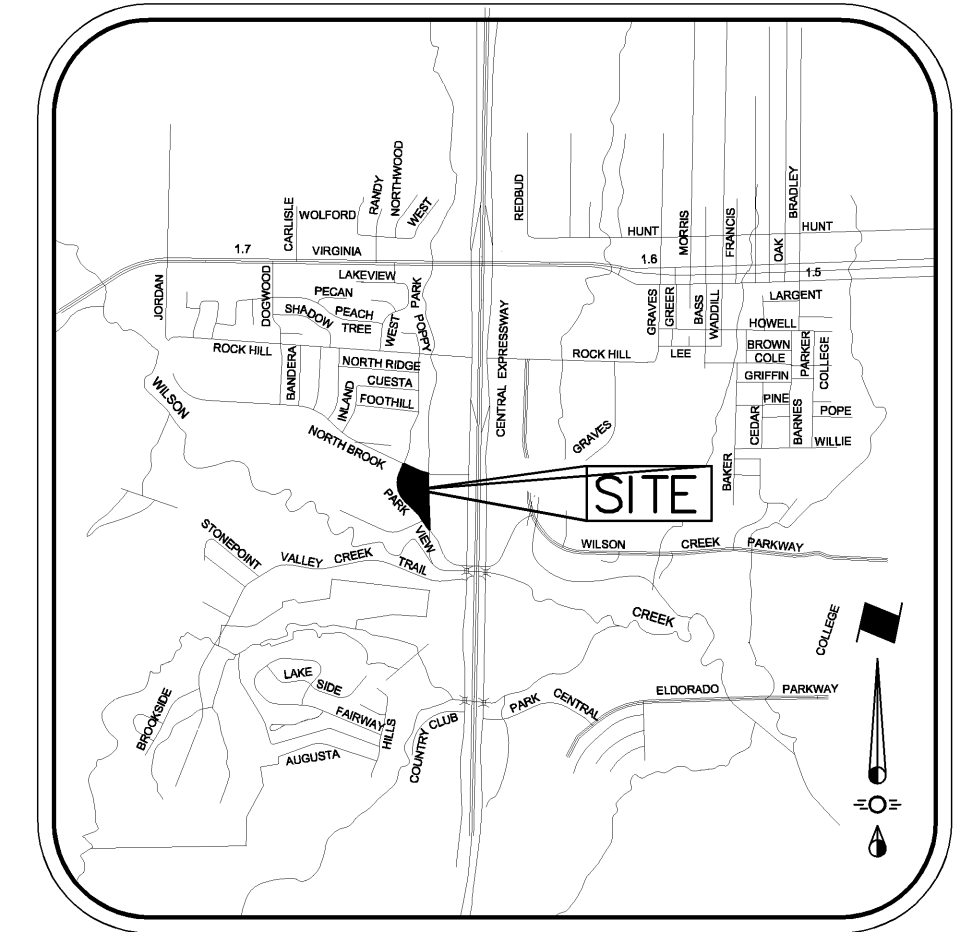

VICINITY MAP
NTS

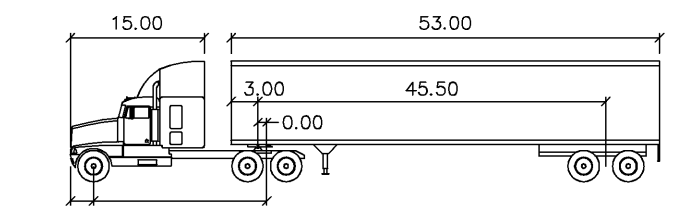
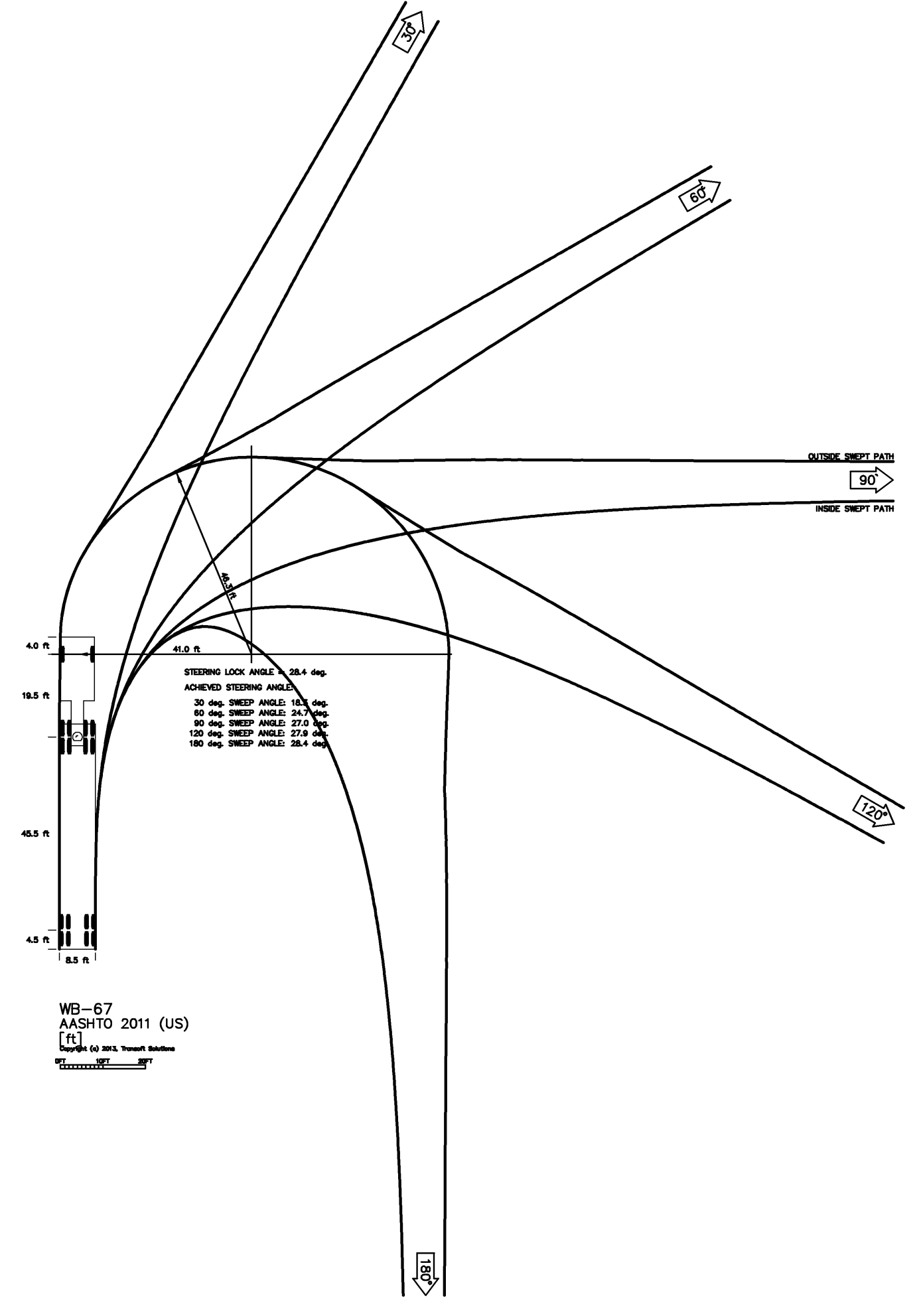
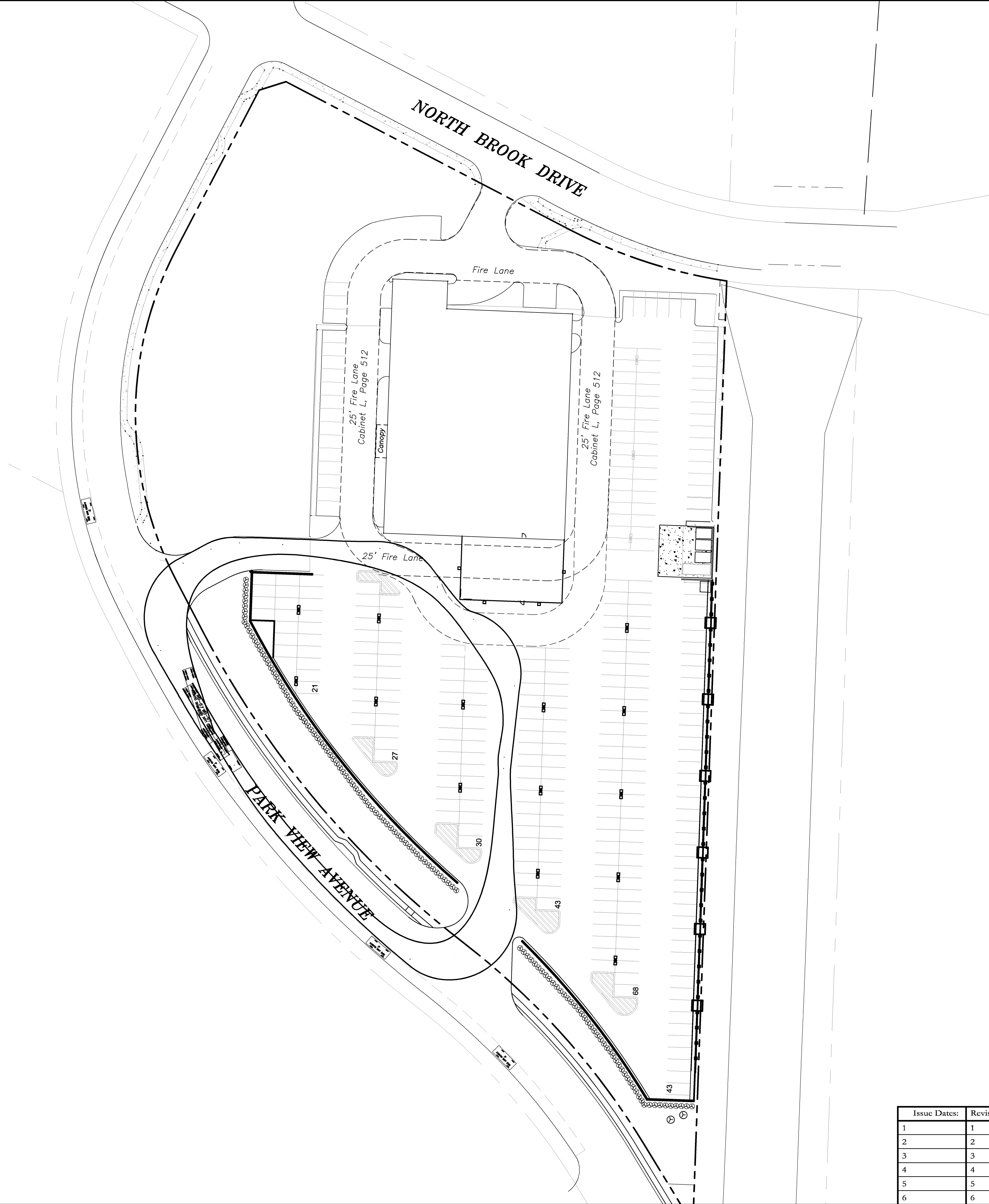
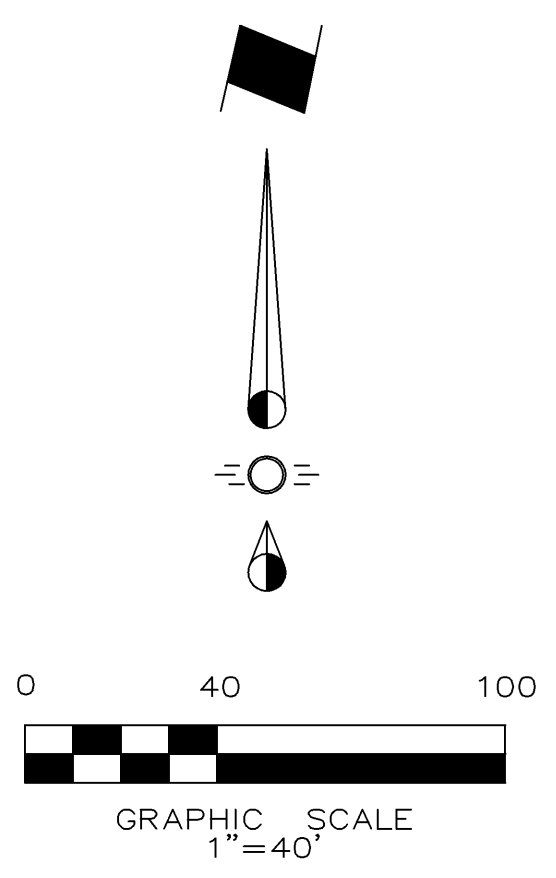

WB-67	feet		
Tractor Width	: 4.00	Lock to Lock Time	: 6.0
Trailer Width	: 15.00	Steering Angle	: 28.4
Tractor Track	: 8.00	Articulating Angle	: 72.0
Trailer Track	: 8.50		

Issue Dates:	Revisions:	Date:
1	1	
2	2	
3	3	
4	4	
5	5	
6	6	

CROSS ENGINEERING CONSULTANTS
 131 S. Tennessee St. McKinney, Texas 75069
 972.562.4409 Texas P.E. Firm No. F-5935

Drawn By:	Checked By:	Scale:
C.E.C.I.	C.E.C.I.	1"=40'

Autoturn Exhibit South-South
 Variable Setback Layout
BOB TOMES COLLISION CENTER
 PARKING EXPANSION
 BLOCK Q, NORTH BROOK
 MCKINNEY, TEXAS

Sheet No.
AE7
Project No.
13094

Z:\PROJECTS\2013 Job Files\13094 Bob Tomes Collision\13094 AutoTurn-variable setback.dwg, 1/30/2014, 4:14:17 PM, RJP, 5000-overwrite.c3, Chris Wilson

BOB TOMES COLLISION CENTER PARKING EXPANSION

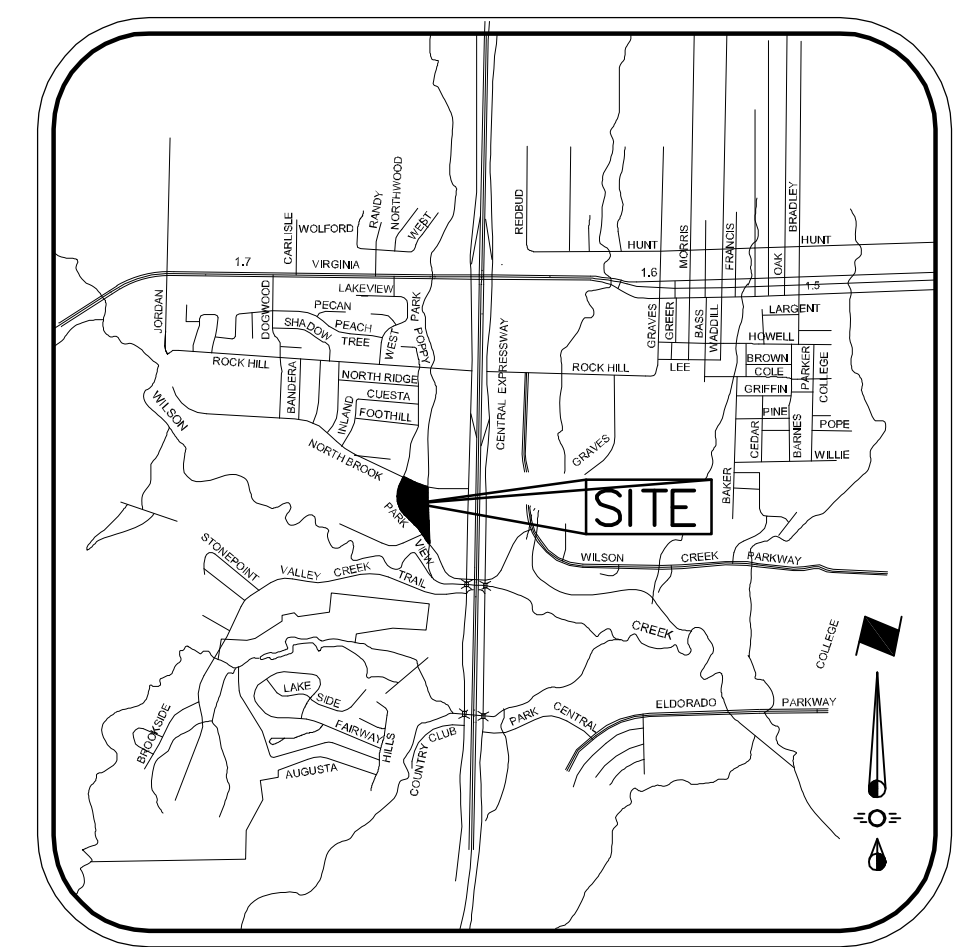
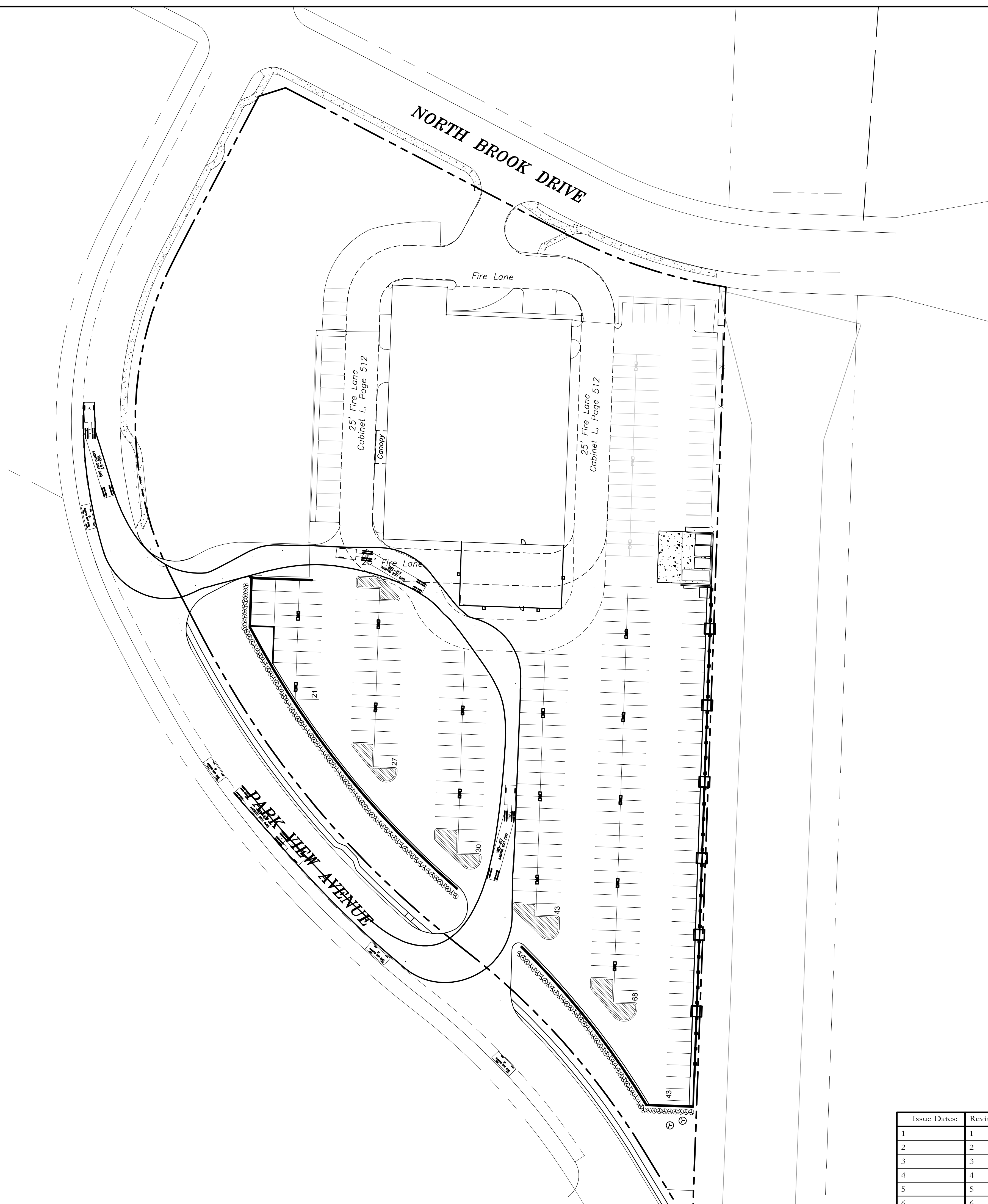

VICINITY MAP
NTS

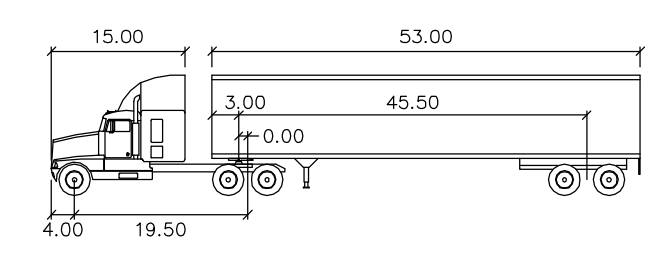
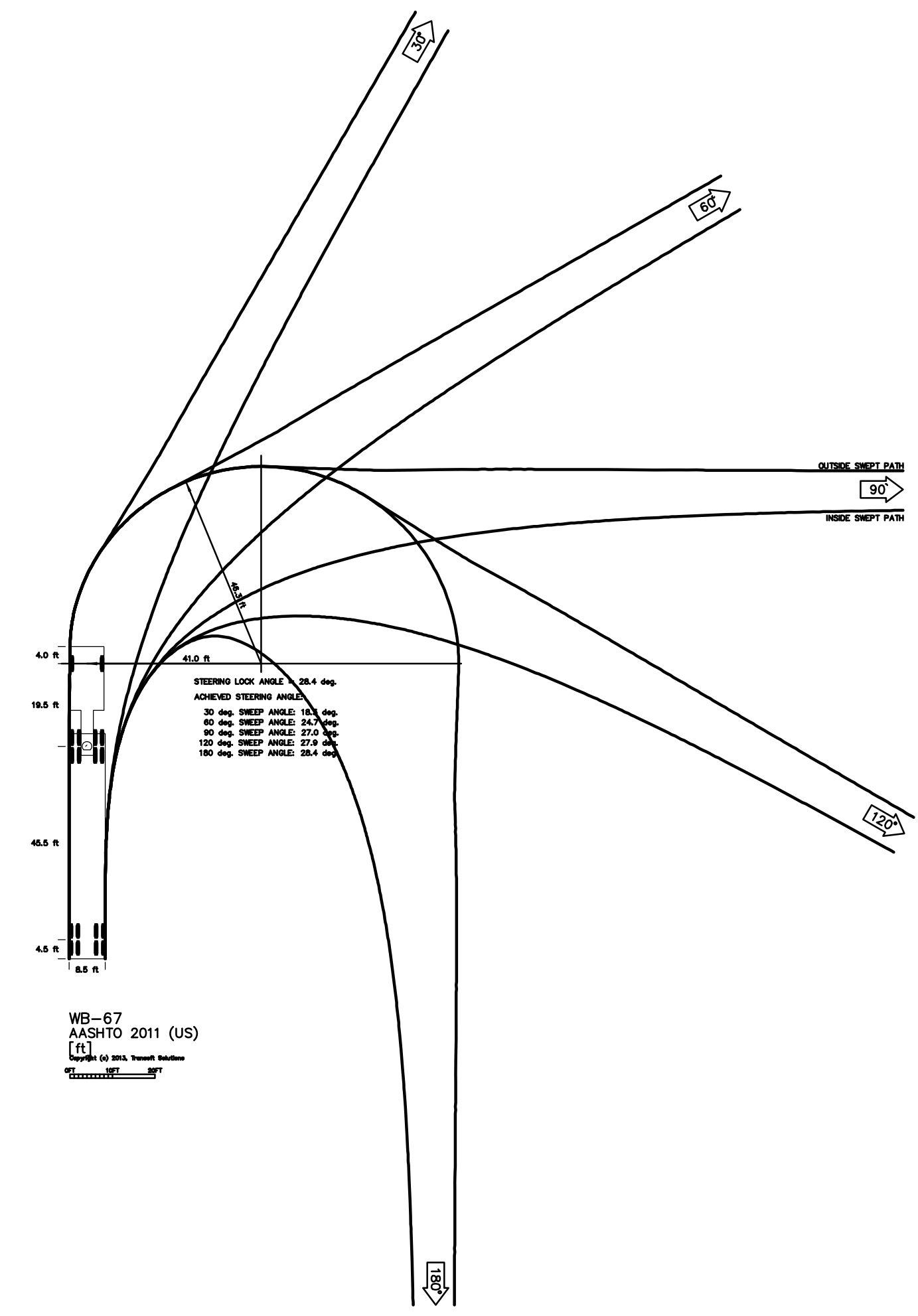
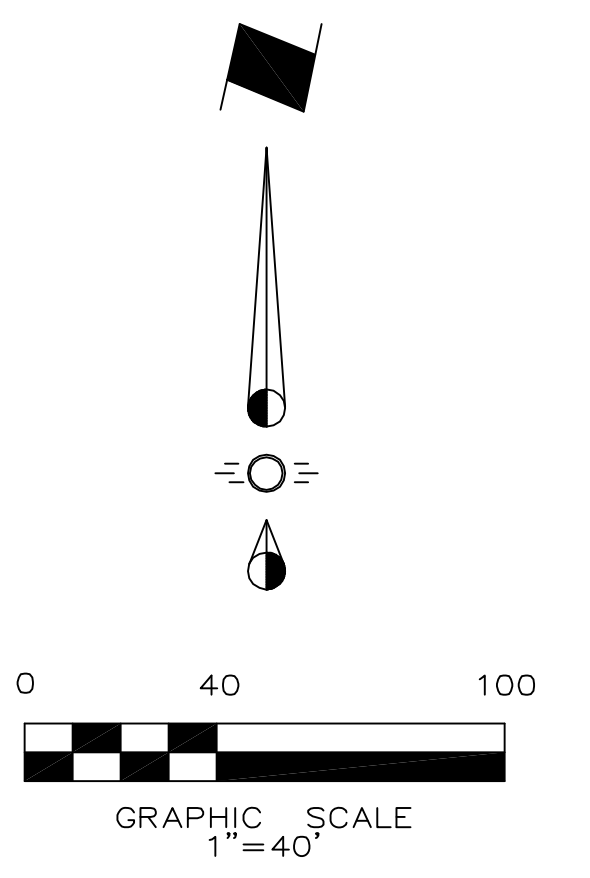

WB-67	feet	
Tractor Width	: 8.00	Lock to Lock Time : 6.0
Trailer Width	: 8.50	Steering Angle : 28.4
Tractor Track	: 8.00	Articulating Angle : 75.0
Trailer Track	: 8.50	

Issue Dates:	Revisions:	Date:
1	1	
2	2	
3	3	
4	4	
5	5	
6	6	

CROSS ENGINEERING CONSULTANTS
 131 S. Tennessee St. McKinney, Texas 75069
 972.562.4409 Texas P.E. Firm No. F-5935

Drawn By:	Checked By:	Scale:
C.E.C.I.	C.E.C.I.	1"=40'

Autoturn Exhibit South-North
 Variable Seback Layout
**BOB TOMES COLLISION CENTER
 PARKING EXPANSION**
 BLOCK Q, NORTH BROOK
 MCKINNEY, TEXAS

Sheet No.
AE8
 Project No.
 13094

ENGINEER:
 Cross Engineering Consultants, Inc.
 131 S. Tennessee St.
 McKinney, Texas 75069
 Phone (972) 562-4409
 Fax (972) 562-4471
 Contact: Jon David Cross, P.E.

ARCHITECT:
 IAM Construction
 6900 North Dallas Parkway,
 Suite 770
 Plano, Texas 75024
 Phone (972) 608-8988
 Fax (972) 403-9292
 Contact: Scott Bryant

SURVEYOR:
 AJ Bedford Group, Inc.
 301 N. Alamo Road
 Rockwall, Texas 75087
 Phone (972) 722-0225
 Fax (972) 722-0361
 Contact: Jay Bedford

BOB TOMES COLLISION CENTER PARKING EXPANSION